

e. 3

LA-3473

CIC-14 REPORT COLLECTION  
**REPRODUCTION  
COPY**

**LOS ALAMOS SCIENTIFIC LABORATORY**  
of the  
**University of California**  
LOS ALAMOS • NEW MEXICO

**The Scandium-Hydrogen System**



UNITED STATES  
ATOMIC ENERGY COMMISSION  
CONTRACT W-7405-ENG. 36

## LEGAL NOTICE

This report was prepared as an account of Government sponsored work. Neither the United States, nor the Commission, nor any person acting on behalf of the Commission:

A. Makes any warranty or representation, expressed or implied, with respect to the accuracy, completeness, or usefulness of the information contained in this report, or that the use of any information, apparatus, method, or process disclosed in this report may not infringe privately owned rights; or

B. Assumes any liabilities with respect to the use of, or for damages resulting from the use of any information, apparatus, method, or process disclosed in this report.

As used in the above, "person acting on behalf of the Commission" includes any employee or contractor of the Commission, or employee of such contractor, to the extent that such employee or contractor of the Commission, or employee of such contractor prepares, disseminates, or provides access to, any information pursuant to his employment or contract with the Commission, or his employment with such contractor.

This report expresses the opinions of the author or authors and does not necessarily reflect the opinions or views of the Los Alamos Scientific Laboratory.

Printed in USA. Price \$2.00. Available from the Clearinghouse for Federal Scientific and Technical Information, National Bureau of Standards, United States Department of Commerce, Springfield, Virginia

LA-3473  
UC-4, CHEMISTRY  
TID-4500

**LOS ALAMOS SCIENTIFIC LABORATORY**  
**of the**  
**University of California**  
LOS ALAMOS • NEW MEXICO

Report written: January 1966

Report distributed: May 24, 1966

**The Scandium-Hydrogen System**

by

J. F. Stampfer, Jr.





### ABSTRACT

A partial phase diagram for the scandium-hydrogen system was determined in the temperature range from 700° to 900°C and compositions ranging from ScH<sub>0.4</sub> to ScH<sub>2.0</sub>. The equation which relates the hydrogen pressure over the supposed two solid phase region to the temperature was found to be

$$\log P_{\text{torr}} = - \frac{(10.467 \pm 0.552)10^3}{T} + (10.527 \pm 0.512).$$

In this same region, the heat of formation of the hydrogen-rich phase from one mole of hydrogen and the hydrogen-poor phase was found to be -47.9 kcal/mole of H<sub>2</sub>. Both the pressure equation and the heat of formation agree closely with other recently published data.

In the "plateau" region, the higher temperature isotherms have a definite slope which should not be the case if there are only two components and two phases. Although there is a possibility that the presence of impurities may be the cause of the slope, the evidence is that this is not the case. No other explanation is offered.

## PREFACE

This report covers the research performed on the scandium-hydrogen system to the summer of 1964. Further work had been intended, but a report covering this same metal hydride system was given at the 148th national meeting of the American Chemical Society by M. L. Lieberman and P. G. Wahlbeck of Illinois Institute of Technology and has recently appeared in the literature.<sup>1</sup> It was felt that the data shown in this report corroborate that of Lieberman and Wahlbeck to such an extent that further effort would be superfluous.

## CONTENTS

	Page
ABSTRACT	3
PREFACE	4
INTRODUCTION	7
EXPERIMENTAL	8
A. Apparatus	8
1. Vacuum System	8
2. Pressure Measuring System	10
3. Reactor	11
4. Furnace	11
5. Temperature Measuring System	13
B. Scandium	13
C. Method	14
RESULTS AND DISCUSSION	17
REFERENCES	29

## FIGURES

1. Schematic of experimental system.	9
2. Reactor.	12
3. Example of heating curve, pressure vs. temperature.	16
4. 800°C isotherm.	18
5. Plateau region of 900°C isotherm.	20

FIGURES (Continued)

	Page
6. Composition of knee vs. temperature	22
7. 750°C (a) and (b) isotherms.	24
8. Summary of isotherm data.	26
9. Log P <sub>torr</sub> vs. 1/T <sub>(ok)</sub> .	27



## INTRODUCTION

Interest in the scandium-hydrogen system was twofold. First, it was felt that scandium might be capable of containing large quantities of hydrogen. Second, the results would help complete the growing mass of data on the simple metal hydrogen compounds by providing the description of a system for which there was no information.

Although there were no data covering this system known to the author when this project was proposed and started, three pieces of data became available while the research was underway. Warf and Hardcastle<sup>2</sup> reported the failure to form the trihydride at conditions up to 40 atmospheres of hydrogen and 400°C. Beck<sup>3</sup> reported four isotherms between 900° and 1100°C, but the data points shown were few. McGuire and Kempter<sup>4</sup> reported crystallographic data and "Vapor Pressure Data for ScH<sub>2</sub>." From the latter numbers, an enthalpy change was calculated which did not appear wholly reasonable.

It was hoped that this research would not only provide P-C-T data, which would allow the calculation of various thermodynamic functions for this system, but would also allow the determination of at least a partial phase diagram. Although these purposes were not wholly attained, an amount of fairly reliable data was collected.

The method used was the standard volumetric one using a Sieverts apparatus. First, excess hydrogen was reacted with scandium metal. It was necessary to start with the completely hydrided material each time as it was exceedingly difficult to pump all the hydrogen out of the metal. As previous experiments had shown that under these conditions the composition of the solid was  $\text{ScH}_{2.00}$  within experimental limits, it was assumed that in each case, after complete reaction, the dihydride was present.

While the solid was maintained at constant temperature, aliquots of hydrogen were removed until the pressure over the solid was about one torr or less. Subsequently, measured portions of hydrogen were added to final pressures approximating one local atmosphere. As the pressure, temperature, and volume of the system were known, the composition of the solid after each removal or addition of hydrogen could be calculated.

## EXPERIMENTAL

### A. Apparatus

The apparatus can be divided into five parts: vacuum system, pressure measuring system, reactor, furnace, and temperature measuring system.

#### 1. Vacuum System

In essence, this was simply a Sieverts apparatus (see Fig. 1). Hydrogen, generated from uranium hydride (a) and 99.9+% pure, with tank helium and spectroscopic argon, was stored in glass bulbs (b). These bulbs were connected to the main part of the vacuum system past a mercury manometer (c) to allow measurement of gas pressures before admission to the rest of the system. A gas burette (d) was also connected here so that known volumes of gas could be transferred.

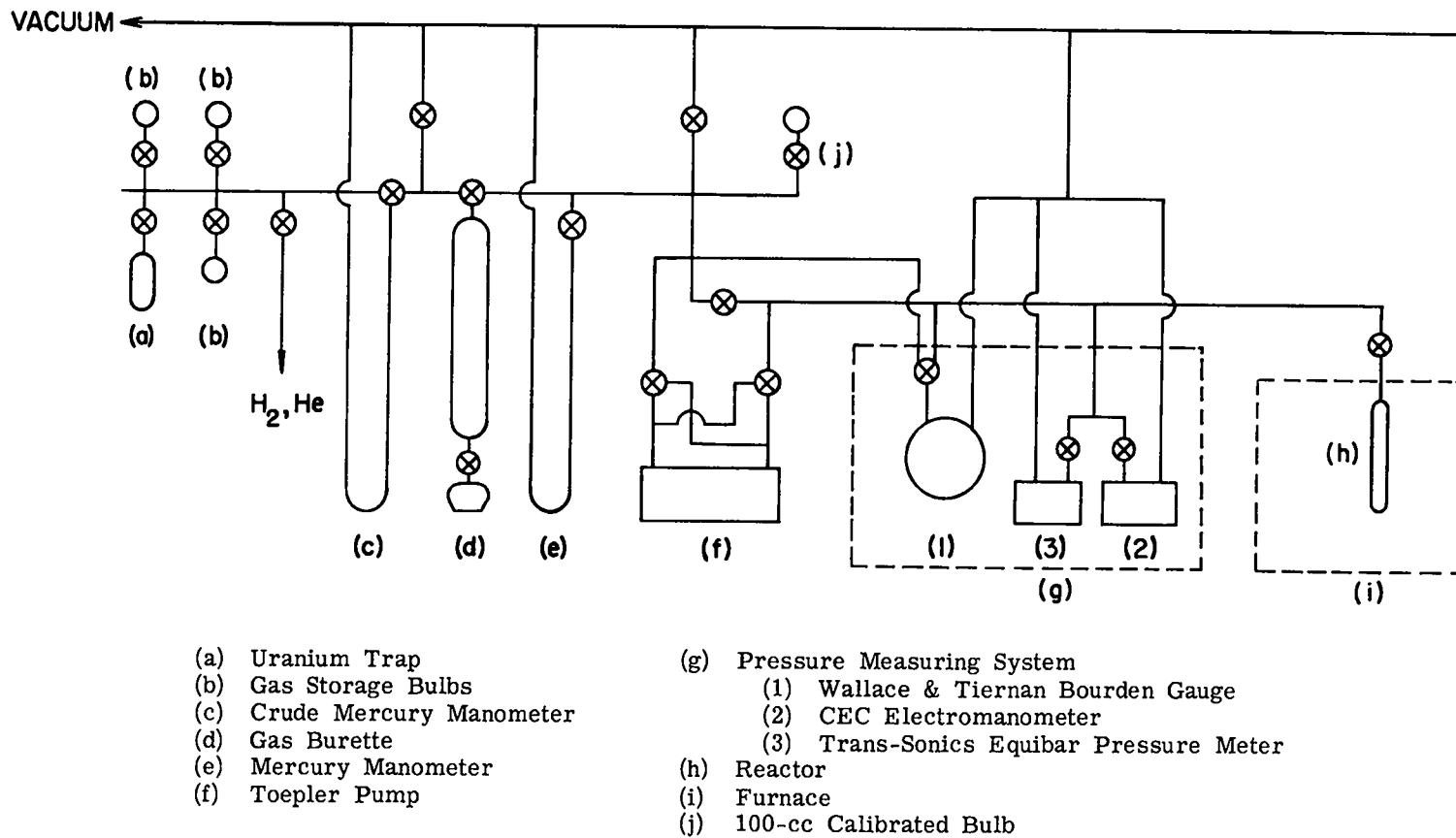

Fig. 1. Schematic of experimental system.

This burette was used mainly for volume calibrating. The mercury manometer (e), which was read with a cathetometer, was used for calibrating the higher range pressure gauges. The Toepler pump (f) allowed pumping of gas either into or out of the reactor and pressure gauges. In this way, larger aliquots of hydrogen could be removed from the reactor at low pressures than would have been possible if the decomposition pressure were the controlling factor.

## 2. Pressure Measuring System

Pressures in the system were measured with three different gauges (g):

- a. 0-760 torr: Wallace and Tiernan Model FA-145 expanded-range bourdon tube gauge. This was calibrated against the mercury manometer (e).
- b. 0-5 psi: CEC precision pressure balance and Type 1-124A electromanometer servo amplifier. This was calibrated against a CEC piston gauge.
- c. 0-30 torr: Trans-Sonics Equibar pressure meter. This was calibrated against a CEC 1.5-psi precision pressure balance and servo amplifier and a CEC micromanometer.

It is felt that pressures were known to, at least, the following accuracies:

<u>Torr</u>	<u>Accuracy</u>
5 - 600	1%
0.5 - 5	$\pm 50\mu$
<0.5	$\pm 30\mu$

Below  $100\mu$ , the accuracy was undoubtedly better than  $\pm 30\mu$ , but there was no good calibration at

these pressures. Sensitivities were as follows:

<u>Torr</u>	
<u>Pressure</u>	<u>Sensitivity</u>
250 - 600	0.5
25 - 250	0.05
0.001 - 25	0.001

### 3. Reactor (h)

The major experimental difficulty encountered in this research was the lack of a completely inert reactor. Both mullite and recrystallized alumina were originally tried, but both appeared to be attacked by the scandium. (It is presently believed that recrystallized alumina may be suitable and that the attack noted above may have been caused by something other than the scandium.) More in desperation than hope, and because it was readily available, quartz was tried and appeared to be satisfactory. The diffusion of hydrogen out of, and air into, this reactor placed a practical upper limit of 900°C on these experiments.

In all cases the reactor (Fig. 2) consisted of two concentric tubes with one end closed; the outer one 12-1/2 in. long by 12 mm O.D. and the inner one about 1 in. shorter and 8 mm O.D. The open ends were sealed to pyrex with a connection to the vacuum system. This arrangement left a cavity about 1/2 in. in diameter x 1 in. deep at the bottom of the outer tube, while the majority of the reactor which was in the temperature gradient of the furnace was of small volume. Also, a thermocouple could be inserted into the inner tube and be in close proximity to the sample.

### 4. Furnace

The 10-kW furnace, built by American Furnace Co., was supposedly capable of temperatures in excess of 1500°C. The

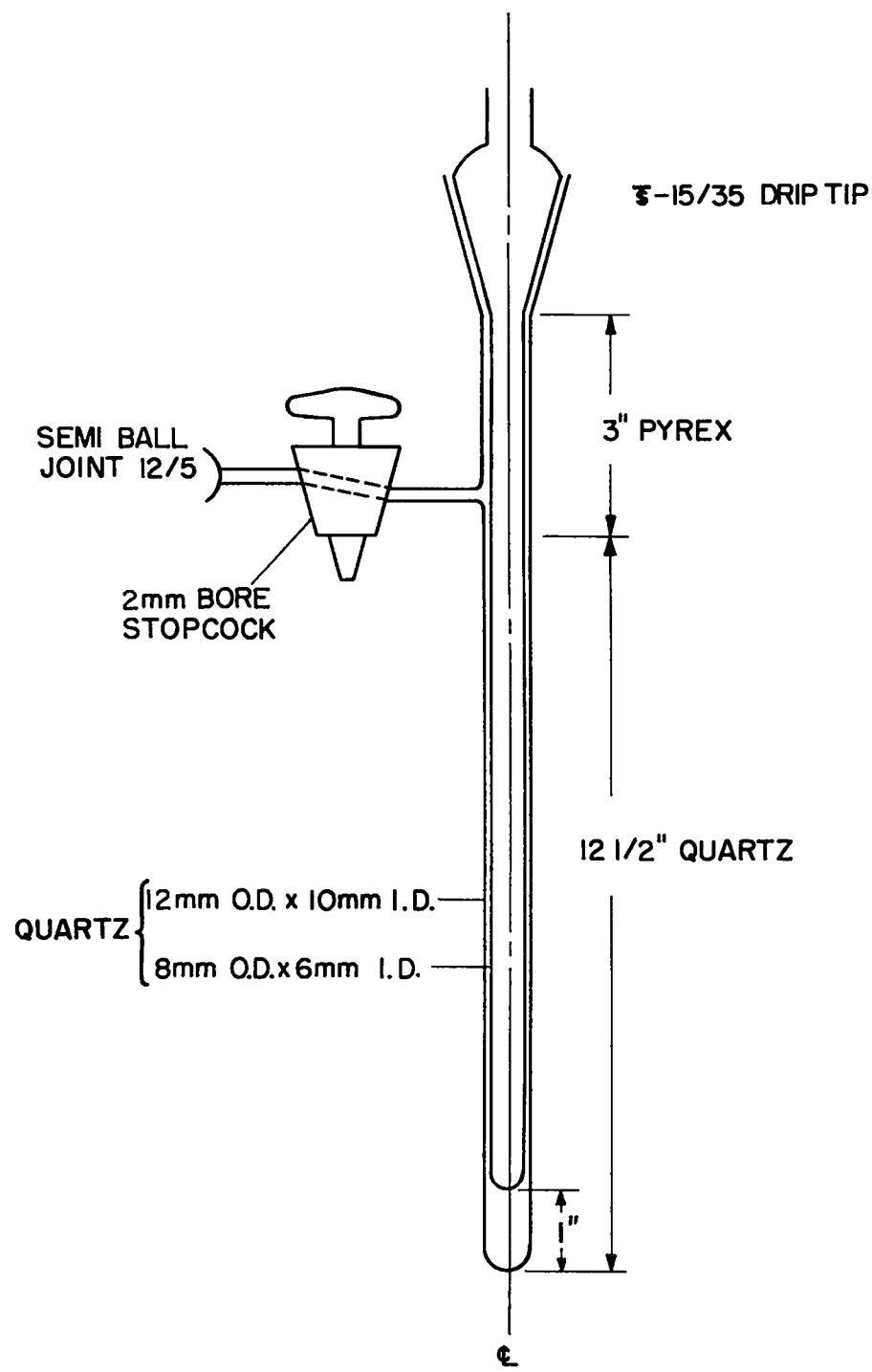

Fig. 2. Reactor.

temperature was usually maintained to within  $\pm 0.5^{\circ}\text{C}$  by use of a Lindeck controller (built by Group P-1, drawing number 4Y-40647). This controller sensed the output of a Pt/Pt, 10% Rh thermocouple and, in turn, activated a relay which controlled the voltage across one of the four pairs of Globar heating elements.

The furnace contained a silicon carbide crucible which held approximately 75 pounds of molten tin to act as a constant temperature bath. This crucible caused trouble as, with time, it was eroded at the tin-air interface and finally allowed molten tin to flow into the bottom of the furnace.

#### 5. Temperature Measuring System

The temperature in the reactor was measured with a Pt/Pt, 10% Rh thermocouple and a Rubicon Type 2782, 5-dial potentiometer. Null was determined with a Leeds and Northrup microvolt indicating amplifier which allowed the off-null voltage to be recorded on a Varian recorder so that a record of the temperature fluctuations was available. The standard cell used was of the saturated type and was kept in an oil bath regulated to within  $\pm 0.1\%$  with a mercury thermostat.

Temperatures during most of the time data were being collected were known to better than 1/2%. However, about two-thirds of the way through the experimental work, there was an apparent shift in the measured temperature of about  $2^{\circ}\text{C}$ . This shift has been taken into account as far as possible in the data presented below.

#### B. Scandium

The scandium metal was obtained from Group CMF-2 where it had been procured for determining the heat of formation of scandium oxide. "It was found by analysis to contain the following percent impurities: C, 0.062; H, 0.0085; O, 0.0375;

N, 0.0075; Ta, 0.009; Mg, 0.01; Al, 0.05; and Y, 0.05. -- If it is assumed that the C, H, O, and N are combined with scandium as the carbide, hydride, oxide, and nitride, the scandium is 99.51 mole % metal (atomic weight of Sc - 44.96)."<sup>5</sup>

### C. Method

The general experimental procedure was as follows. After the reactor, with a previously weighed half-gram sample of scandium, was attached to the vacuum system, all volumes, including the reactor, were calibrated by expansion of helium from the gas burette (d) or a 100-cc calibrated bulb (j). The furnace was turned on, the temperature raised to 700°C, and the reactor thoroughly evacuated. Another volume calibration of the reactor was carried out at this temperature to determine an "effective" volume. As part of the reactor volume was contained in a large temperature gradient, calculations of quantities of gas in the gas phase of the reactor were difficult. To overcome this, the "effective" volume (the apparent volume of the reactor if it was all considered to be at room temperature) was determined. As the diffusion of helium through the quartz was excessive at elevated temperature, only one calibration was carried out in this regime. From this value and the one at room temperature, the effective volumes at other temperatures were calculated. At the conclusion of the experiments, the reactor was calibrated again, this time with argon, at 700°C and 750°C. This gas showed no detectable diffusion at these temperatures, and these values agreed quite well with the ones determined and calculated previously. As will be seen in the data which follow, the pressure change in the reactor for the removal or addition of any one aliquot of gas is usually small, and, therefore, the change in quantity of gas in the gas phase of the reactor is also small. Thus,



the volume calibration in this part of the system is not as critical as in the rest of the system.

The first datum obtained was the total quantity of hydrogen taken up by the metal. This was found to correspond to a solid composition of  $\text{ScH}_{1.992}$ . As it was felt that the difference between this value and  $\text{ScH}_{2.000}$  was within experimental error, the composition of the completely hydrided solid was always assumed to be the latter value.

Because it was exceedingly difficult to pump all of the hydrogen out of the metal before the determination of any isotherm, the metal was completely hydrided. As the decomposition pressure of the hydride was greater than one local atmosphere at temperatures as low as  $650^{\circ}\text{C}$ , the temperature was lowered to  $400^{\circ}\text{C}$  and the metal allowed to react with 550 torr of hydrogen for at least 24 hours. The temperature was then slowly increased. When the pressure in the reactor approached 590 torr, a known amount of hydrogen was removed. This process was continued until the desired temperature was reached. Because the total amount of hydrogen removed was known, and assuming that the original composition of the solid was  $\text{ScH}_{2.000}$ , the composition at the start of the isotherm could be calculated. Figure 3 is a typical plot of the above procedure.

After a constant temperature had been achieved, the isotherm data were obtained by removal of portions of hydrogen. By knowing (a) the total quantity of hydrogen present in the hydride, (b) the total amount removed, and (c) the amount in the gas phase in the reactor after the removal, the total amount in the solid could be calculated. The quantities (b) and (c) were calculated using the ideal gas law and the appropriate pressures, volumes, and temperatures. The quantity (a) is simply the result of the calculation of the amount

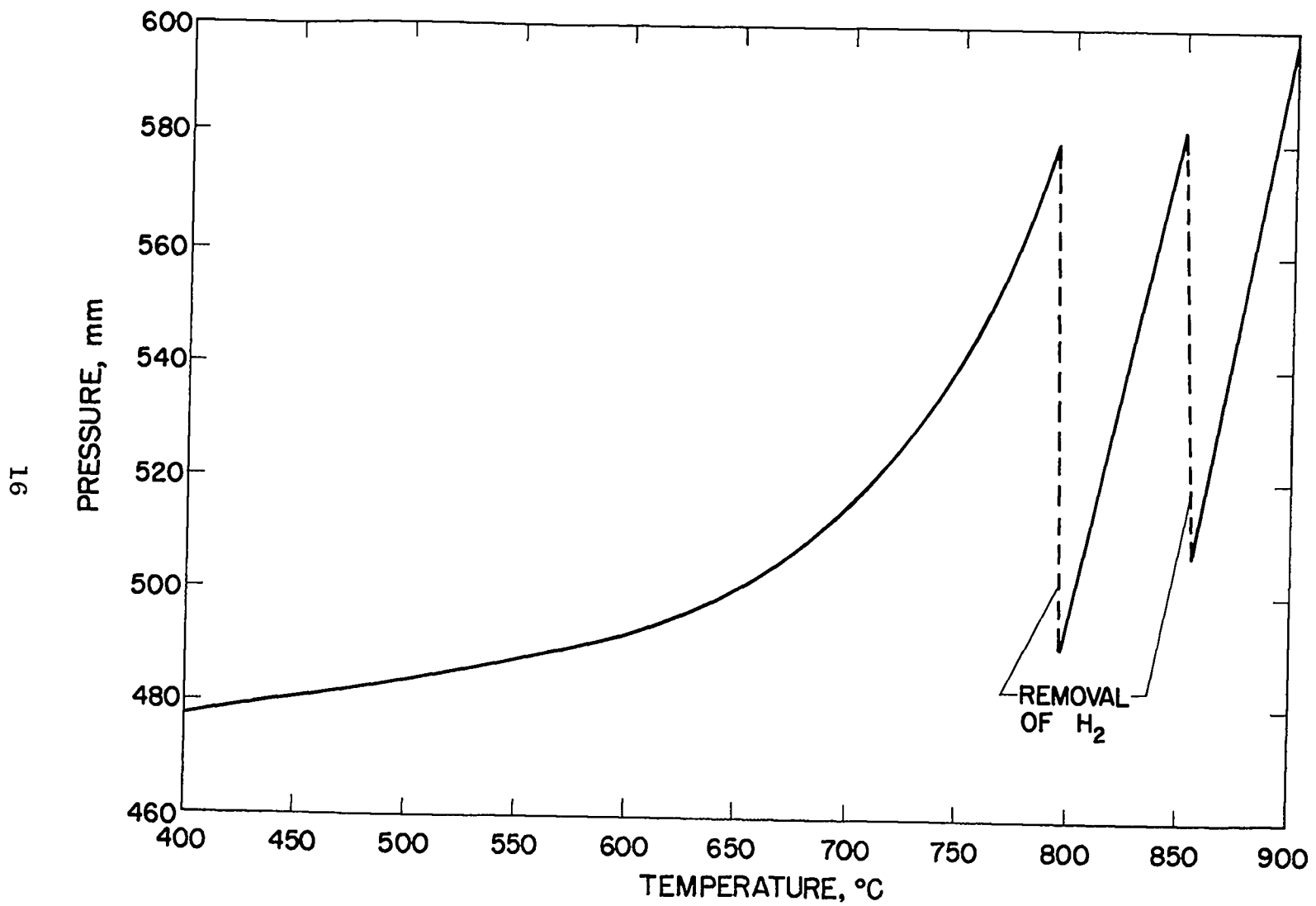

Fig. 3. Example of heating curve, pressure vs. temperature.

of hydrogen remaining in the solid after the previous withdrawal. After enough hydrogen had been removed to give a pressure of approximately 1 torr or less, aliquots of gas were added and the composition after each addition calculated.

After the removal or addition of hydrogen, the system was considered to be in equilibrium when the pressure rose and fell, corresponding as exactly as could be determined with the temperature cycles. These temperature cycles, held to within  $\pm 0.5^{\circ}\text{C}$  of the mean, were of approximately 15 minutes duration and were a consequence of the method of temperature control. As the temperatures could be recorded to  $0.1^{\circ}\text{C}$  and the pressures, below 30 torr, to better than  $1\mu$ , it was felt that this was a good measure of equilibrium. As each isotherm was determined by 20 to 40 points, about half determined on dehydriding and the other half on the subsequent hydriding, the results of nonequilibrium should have been apparent.

## RESULTS AND DISCUSSION

A typical isotherm ( $800^{\circ}\text{C}$ ) is shown in Fig. 4. For purposes of further discussion, the various portions of the curve are defined in the figure.

As will be noted, the agreement between points taken on dehydriding and on the subsequent hydriding shows little difference. This was true of all the data except on first hydriding the sample at  $700^{\circ}\text{C}$ . In this instance, the second solid phase did not appear immediately at the knee, and a pressure maximum was obtained.

As can be seen from the phase rule,

$$F = C - P + 2,$$

F = degrees of freedom,

C = number of components (in this case two, hydrogen and scandium),

P = number of phases,

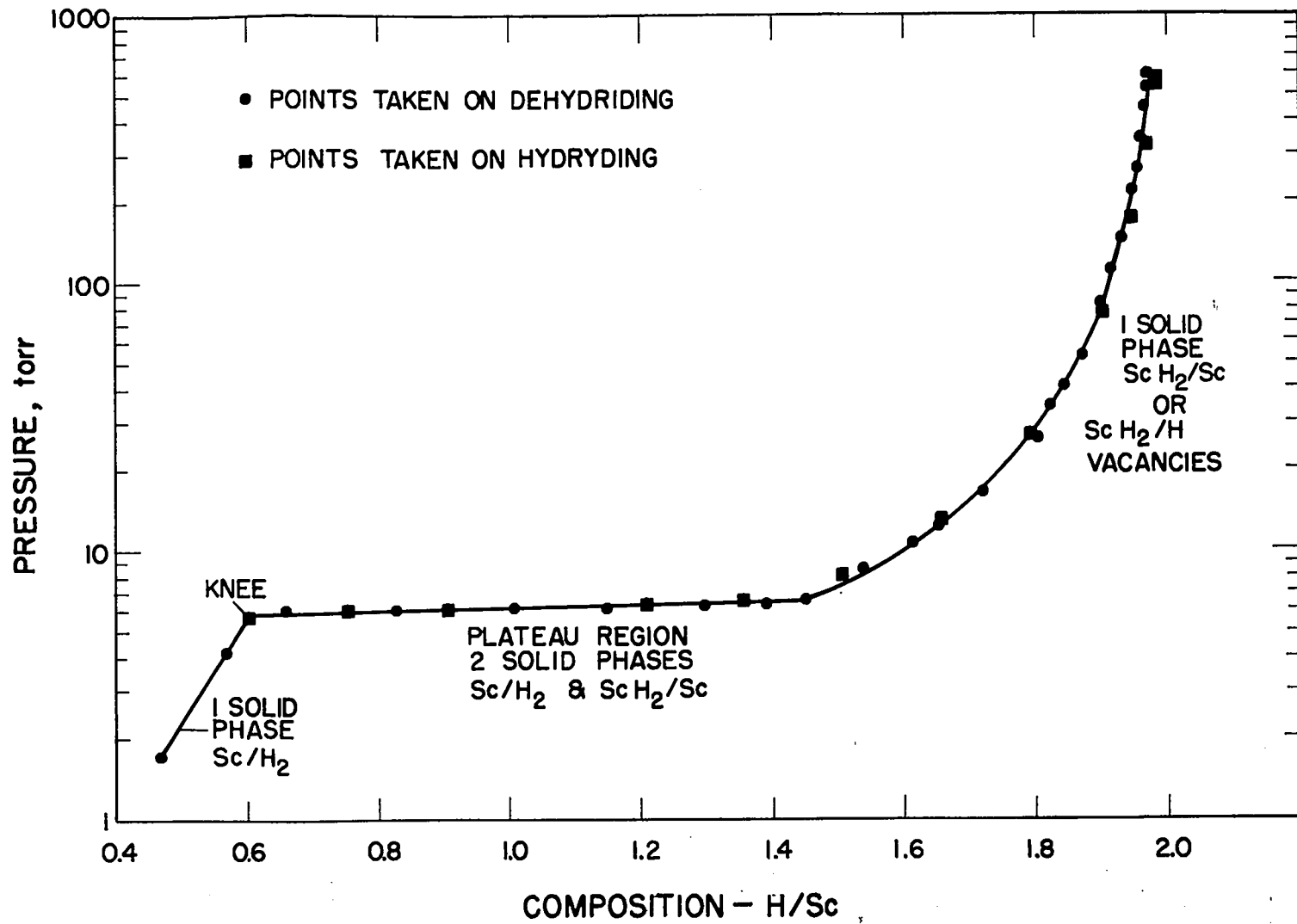

Fig. 4. 800°C isotherm.

within the two solid phase region (three phases total), there is only one degree of freedom, and thus the pressure should be constant at a given temperature over a solid composition range. This was indeed true of the 700° and 750°C isotherms and more or less of the 800°C (see Fig. 8). However, there is a measurable slope in the 850° and 900°C isotherms. (Figure 5 shows the plateau region of the 900°C isotherm more clearly.) The most obvious explanation for this anomaly is a lack of equilibrium. However, if this were the case, a slope should be most apparent in the lower temperature isotherm. This is the reverse of experience. It should also be noted that the same slope is evident on both hydriding and dehydriding. Finally, as pointed out earlier, a change of a few microns, at least below 30 torr. would have been noticeable.

Although hysteresis has been found in a number of metal hydride systems, notably uranium<sup>6</sup> and palladium,<sup>7</sup> this has referred to a difference in decomposition pressure on hydriding and dehydriding. As already noted, this is not the case here, and it is doubtful whether this behavior can be considered hysteresis.

It is possible, through reaction of the solid with the reactor, that more than two components, scandium and hydrogen, were present, i.e. oxygen and/or silicon. This would mean, actually, that in the plateau region there was more than one degree of freedom. In all studies of metal hydrogen systems, some impurities are always present, and, theoretically, might have to be considered as separate components also. However, in the small concentrations usually present these impurities are ignored insofar as phase rule considerations are concerned. In this case then, the impurity concentrations would have to be much larger for this to be a major factor. If it is assumed that the scandium reacted with the quartz, producing

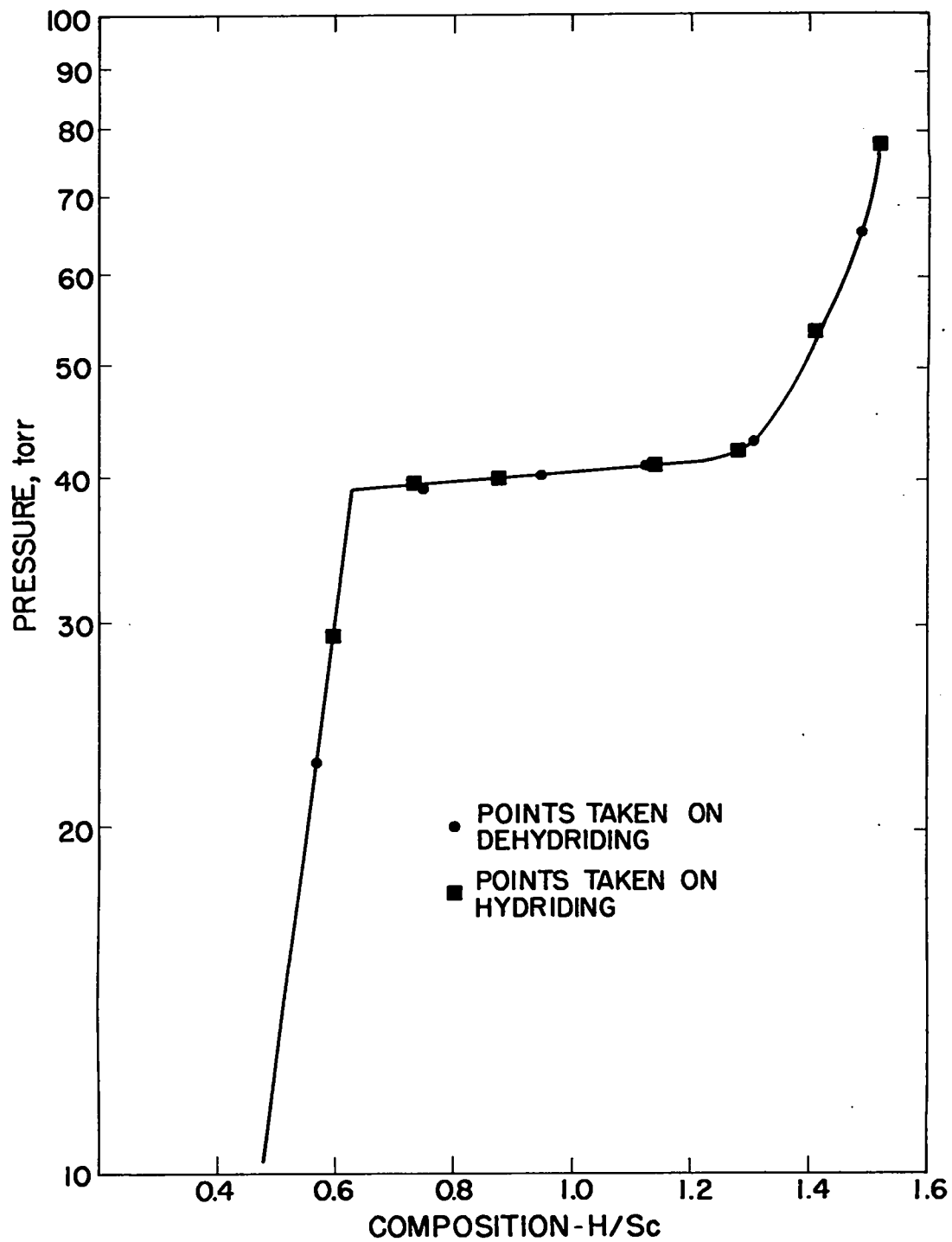

Fig. 5. Plateau region of 900°C isotherm.

$\text{Sc}_2\text{O}_3$ , the maximum quantity of this impurity which could have been present. based on the postulated loss of reactive scandium as explained later, would have been 2.0 m/o at the time the  $850^\circ\text{C}$  isotherm was determined, 2.6 m/o at the time of the  $900^\circ\text{C}$  isotherm, and 3.7 m/o for the last  $700^\circ\text{C}$  isotherm. These quantities are not small and may be significant if the oxide reacts with either of the two major phases. However, it would seem that some slope would be evident in the last isotherms determined, the second  $750^\circ$  and the last  $700^\circ\text{C}$ , which would have had the highest impurity concentrations. As this is not the case, it is probable that any impurities present do not react with the scandium or hydrogen.

This lack of pressure constancy in the supposed two solid phase region is not unique to the scandium-hydrogen system. The phenomenon is fairly common, as shown by the following examples extracted from the literature: praseodymium,<sup>8</sup> plutonium,<sup>9</sup> gadolinium,<sup>3</sup> erbium,<sup>3</sup> and magnesium.<sup>10</sup> The two highest temperature isotherms in the scandium system as reported by Lieberman and Wahlbeck<sup>1</sup> may also show a slight slope although it is not specifically mentioned. No explanation will be attempted here to explain this phenomenon. However, it appears that this region may be more complicated than is usually assumed and certainly warrants further investigation.

Throughout the experiment, the scandium appeared to react slowly with the quartz reactor. Figure 6 shows the H/Sc at the knee for each isotherm and the dates when these data were obtained. In those cases in which two or more isotherms were run at the same temperature but at different times, the later run shows a higher H/Sc. The compositions were based on the assumption that all of the scandium originally loaded (0.5018 grams, 0.01116 moles) was present as the dihydride at the beginning of each isotherm. If the amount of the metal capable

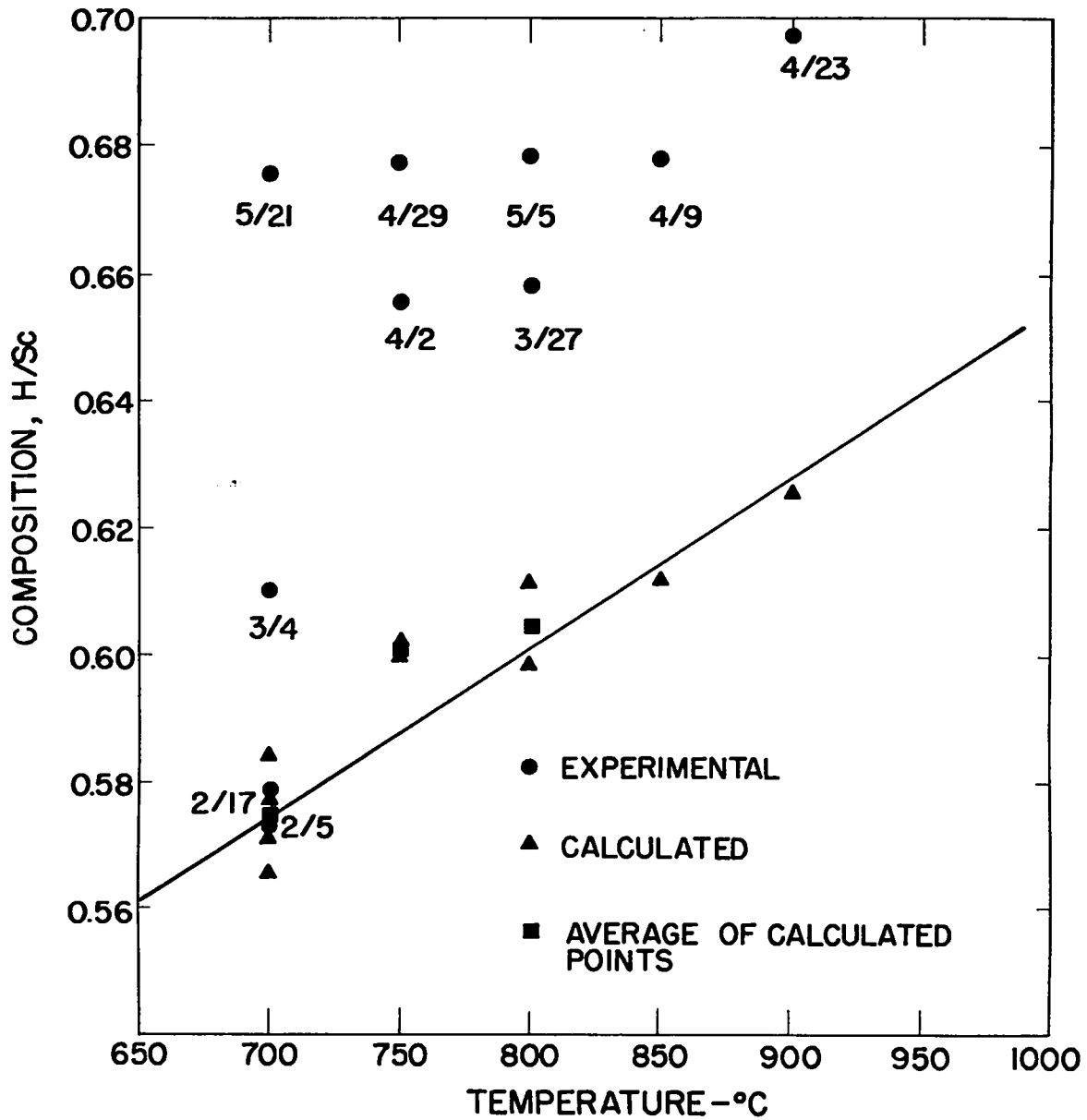

Fig. 6. Composition of knee vs. temperature.



of hydride formation were continually decreasing, for instance by reaction with the quartz reactor, the computed H/Sc would be higher than actual. From the change in the composition of the knee for duplicate isotherms, and assuming a constant loss of scandium with time and temperatures above 500°C, this rate of loss was calculated to be  $7 \times 10^{-6}$  moles Sc/day. Using this value, the compositions at the knees were recalculated, and a straight line was drawn through them. Using the values shown by the straight line, the composition of every experimental point was recalculated. These are the compositions shown throughout this report.

By comparing the measured decomposition pressures in the two solid phase region for duplicate isotherms, it appears that the temperature measuring circuit was indicating a lower than actual temperature during the time the last isotherms were determined. From the values of the decomposition pressures shown in Table 1 and the equation for the straight line in Fig. 9, calculations of the necessary error in temperature to account for the pressure differences at 700°, 750°, and 800° are 4-1/4°, 1/4°, and 1-1/2°C, respectively.

TABLE 1

Temperature (°C)	Decomposition Pressure (Torr)	Composition Limits of Plateau	
		Low H <sub>2</sub> (H/Sc)	High H <sub>2</sub> (H/Sc)
700	0.55	0.575 ± 0.015	1.48 ± 0.05
750	2.19	0.595 ± 0.075	1.35 ± 0.10
800	6.10	0.602 ± 0.030	1.30 ± 0.10
850	15.9	0.615 ± 0.030	1.25 ± 0.05
900	39.0	0.628 ± 0.030	1.225 ± 0.05

As these temperature differences are calculated from fairly small pressure differences, it is not surprising that the agreement is not better. Further, as can be seen from Fig. 7

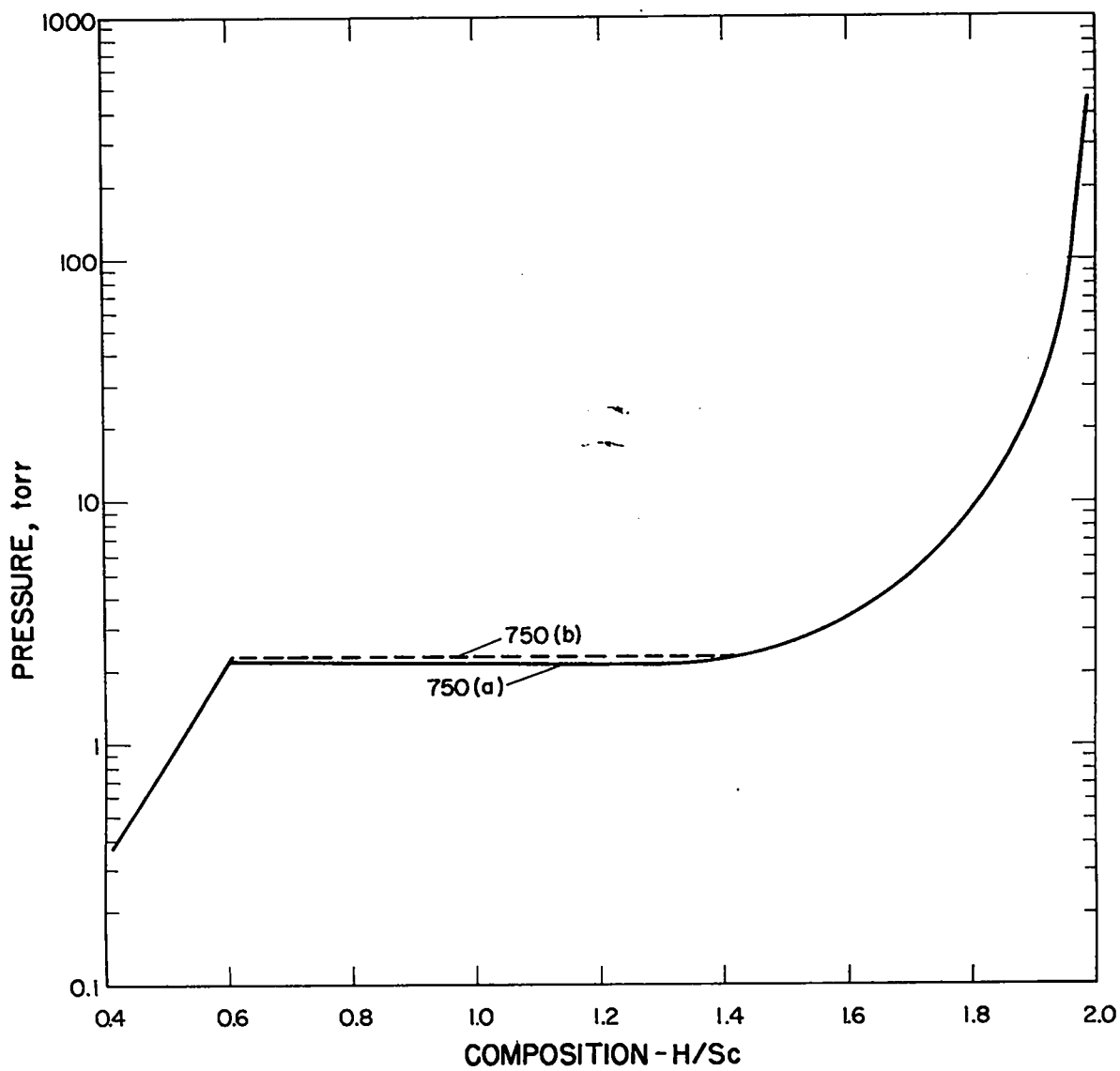

Fig. 7. 750°C (a) and (b) isotherms.

which shows the two 750°C isotherms, this difference in pressure appears to be important only in the two phase region.

The solid lines in Fig. 8 show the five isotherms which were determined in this study. For those duplicate isotherms in which the plateau pressures did not coincide, the pressure shown is that of the first one run. The dotted curves show the approximate boundaries of the two solid phase regions, while Table 1 lists these compositions with an estimate of the uncertainties. While the composition at which the scandium metal becomes saturated with hydrogen is fairly clear-cut, that at which the solid again becomes one solid phase is much more obscure. The best estimates of these compositions were deduced from a differential plot of the change in pressure with composition against the composition.

Figure 9 is a plot of the log of the decomposition pressure of the plateau region, at the knee, against the reciprocal of the absolute temperature for these five isotherms. A quite reasonable straight line was obtained with, possibly, a very slight curvature. A least squares fit of these points yields the equation

$$\log P_{\text{torr}} = - \frac{(10.467 \pm 0.552)10^3}{T} + (10.527 \pm 0.512)$$

where the errors refer to the 90% confidence level. Owing to the small number of points, use of a higher order equation did not appear justified.

The slope of the above line should equal the heat of formation of the second phase from one mole of hydrogen gas and the first phase. The slight curvature of the line, if real, would indicate that either the heat of formation is slightly temperature dependent or that one of the solid phases

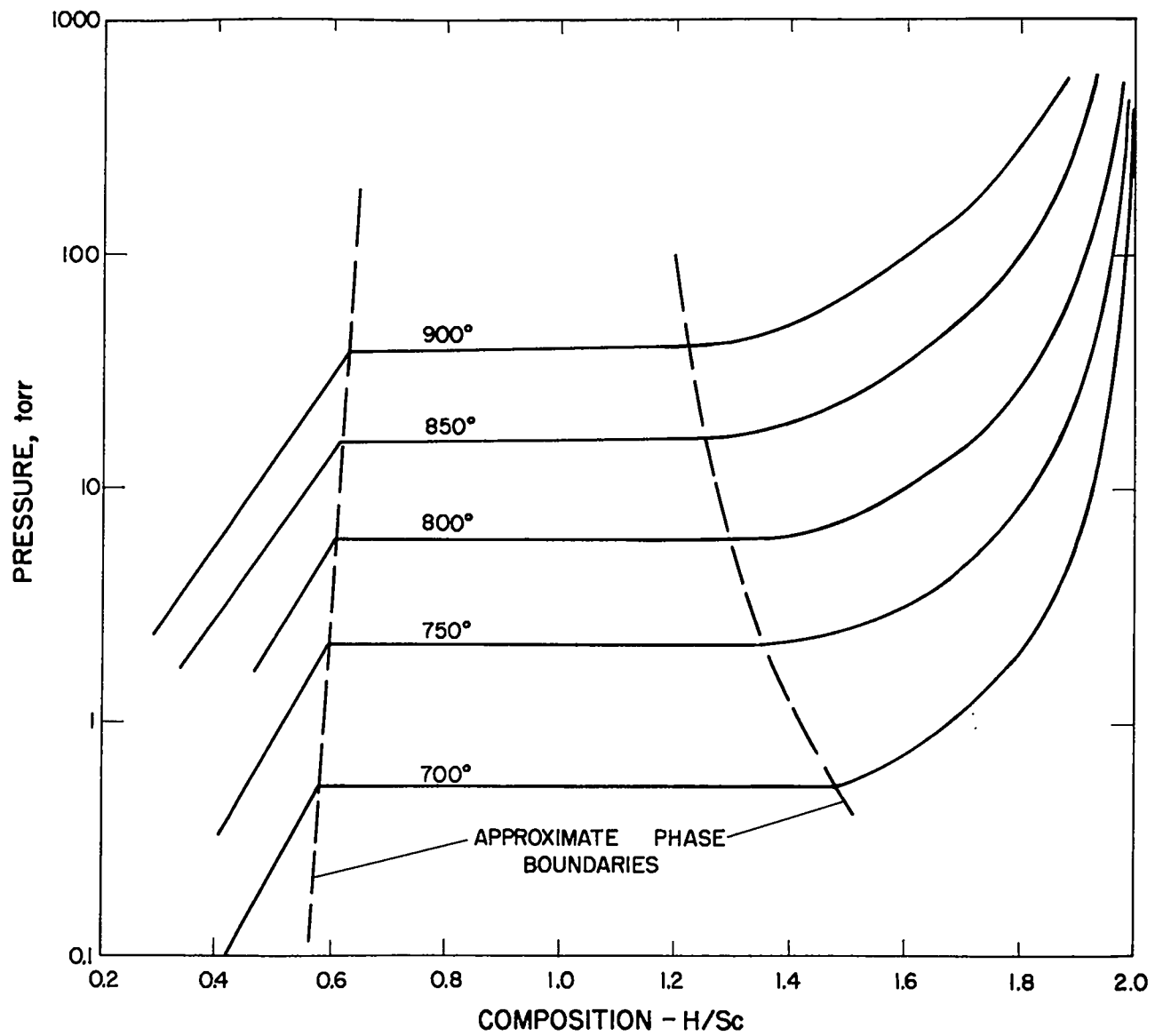

Fig. 8. Summary of isotherm data.

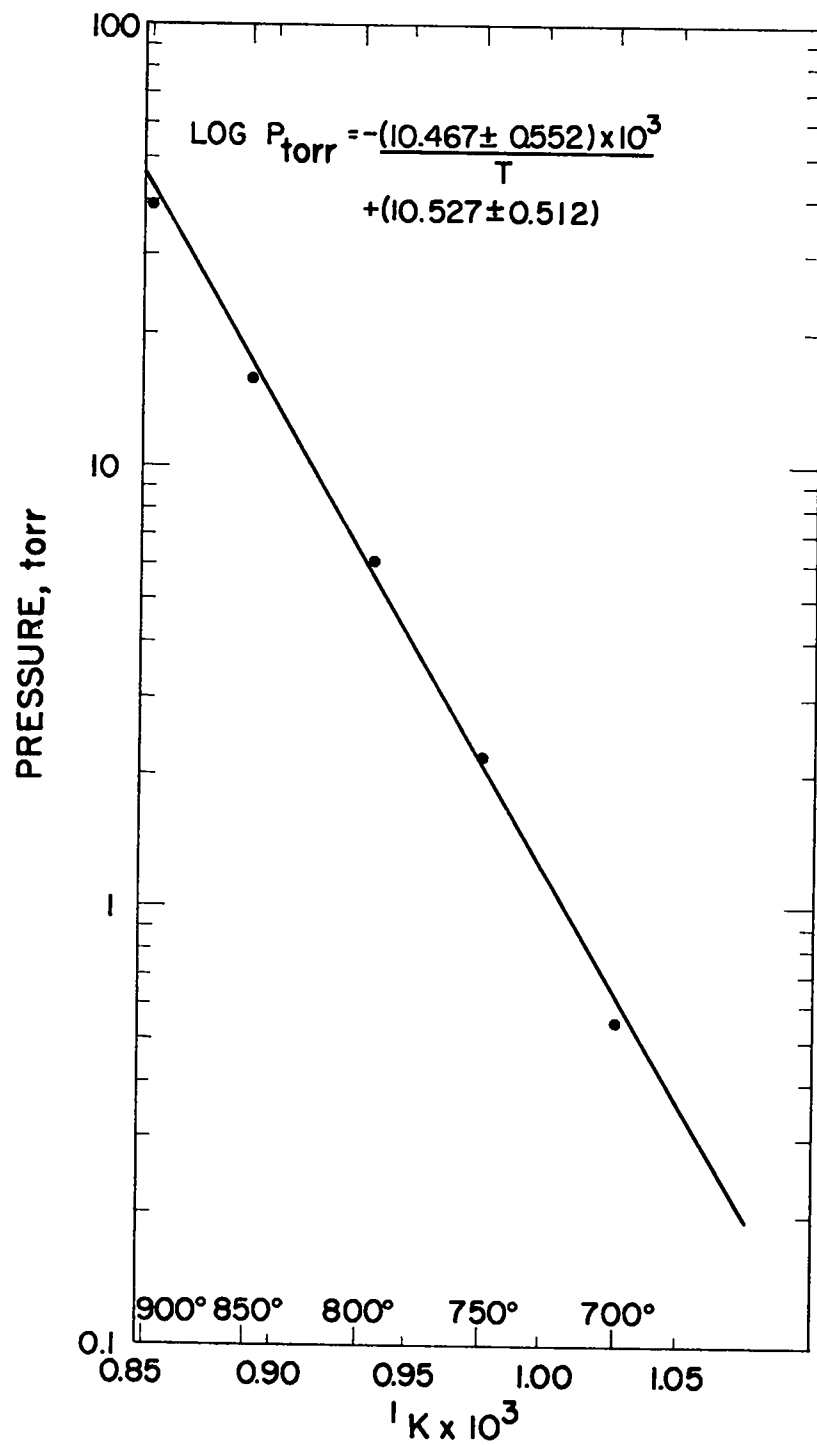

Fig. 9. Log  $P_{\text{torr}}$  vs.  $1/T_{(\text{ok})}$ .

changes with temperature. Nevertheless, neglecting this curvature,

$$\Delta H = -47.9 \text{ kcal/mole}$$

and

$$\Delta F = -47.897 \times 10^3 + 48.172 T \text{ calories}$$

from which

$$\Delta F_{(298)} = -33.5 \text{ kcal/mole.}$$

Although it would be mathematically feasible to calculate other thermodynamic quantities, such as partial molal values, the apparent precision of the data does not seem to warrant this.

A comparison of the data obtained in this work with those reported by Lieberman and Wahlbeck<sup>1</sup> is quite gratifying. As closely as can be determined, the decomposition pressures over the two solid phase region are the same, as are the limits of solubility of hydrogen in scandium. The upper limits of the two solid phase region do not agree as well, differing between 0.1 and 0.2 in the H/Sc, with this work showing the higher ratios. These discrepancies are not surprising in view of the difficulties in determining this point.

The equations for the pressure as a function of temperature and the heat of formation derived from this equation for the two solid phase region show surprisingly good agreement. Lieberman and Wahlbeck report that

$$\log P_{\text{torr}} = - \frac{(10.477 \pm 0.093)10^3}{T} + (10.409 \pm 0.087)$$

and

$$\Delta H = -24.0 \text{ kcal (g-atom of H)}^{-1}.$$

These are to be compared with

$$\log P_{\text{torr}} = - \frac{(10.467 \pm 0.179)10^3}{T} + (10.527 \pm 0.166)$$

and

$$\Delta H = -47.9 \text{ kcal (g-mole of H}_2\text{)}^{-1},$$

where the indicated uncertainties are probable errors.

Finally, neither this work nor the other found any evidence for the existence of a  $\text{ScH}_3$  phase or anything approaching this composition. The highest hydrogen concentration obtained corresponded to a composition of  $\text{ScH}_{2.02}$  and was obtained by Lieberman and Wahlbeck.

#### REFERENCES

1. M. L. Lieberman and P. G. Wahlbeck, *J. Phys. Chem.*, 69, 3514 (1965).
2. J. C. Warf and K. Hardcastle, Office of Naval Research Reports 1 and 2, Contract No. 228 (15), Project No. NR-052-390, August 1961.
3. R. L. Beck, Denver Research Institute Report No. DRI-LAR-10, November 1960.
4. J. C. McGuire and C. P. Kempter, *J. Chem. Phys.*, 33, 1584 (1960).
5. E. J. Huber et al., *J. Phys. Chem.*, 67, 1731 (1963).
6. E. Wicke and K. Otto, *Z. Physik. Chem.*, 31, 222 (1962).
7. D. H. Everett and P. Norden, *Proc. Roy. Soc.*, A259, 341 (1960).
8. R. N. R. Mulford and C. E. Holley, Jr., *J. Phys. Chem.*, 59, 1222 (1955).
9. R. N. R. Mulford and G. E. Sturdy, *J. Am. Chem. Soc.*, 77, 3449 (1955).
10. J. F. Stampfer, Jr., C. E. Holley, Jr., J. F. Suttle, *J. Am. Chem. Soc.*, 82, 3504 (1960).